



# Server Rack Catalog

[www.Cambridge-Rack.com](http://www.Cambridge-Rack.com)

Tel: 8103-0308



## Floor Type Server Rack: 9U to 47U

Standard Feature of 600mm width models:

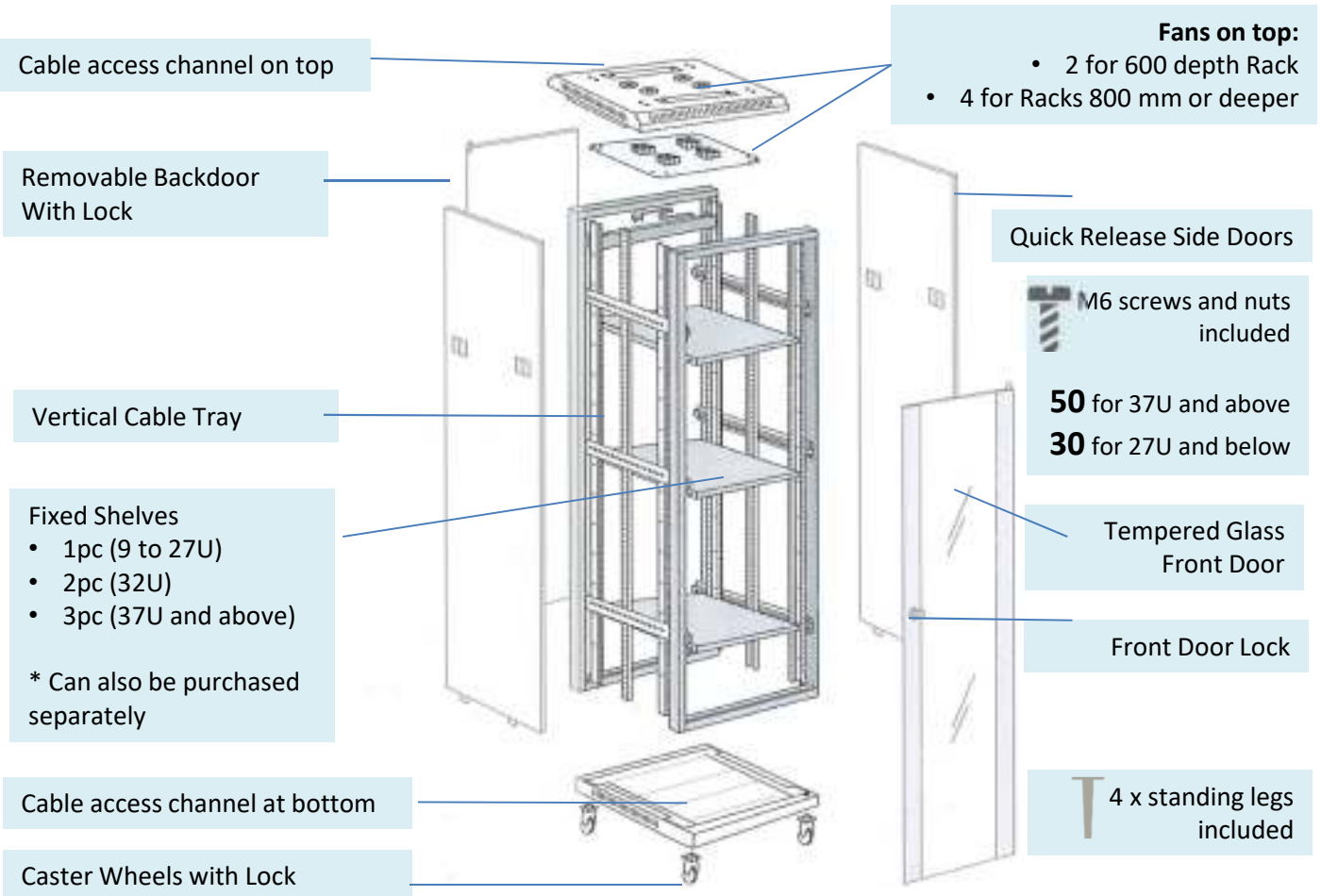

U	Available Width (mm)	Available Depth (mm)	Height with wheels(mm)	Fixed shelves
9	600 / 800	600 / 800 / 900	600	1
12	600 / 800	600 / 800 / 900 / 960 / 1000	720	1
14	600 / 800	600 / 800 / 900 / 960 / 1000	820	1
18	600 / 800	600 / 800 / 900 / 960 / 1000 / 1100	990	1
22	600 / 800	600 / 800 / 900 / 960 / 1000 / 1100	1170	1
27	600 / 800	600 / 800 / 900 / 960 / 1000 / 1100	1400	1
32	600 / 800	600 / 800 / 900 / 960 / 1000 / 1100	1610	2
37	600 / 800	600 / 800 / 900 / 960 / 1000 / 1100	1840	3
42	600 / 800	600 / 800 / 900 / 960 / 1000 / 1100	2050	3
47	600 / 800	600 / 800 / 900 / 960 / 1000 / 1100	2280	3

## Floor Type Server Rack: 9U to 47U

Introduction



### Standard features

- High quality cold roll steel
- Front tempered glass door (with round lock)
- Back steel door (with round lock)
- Delivery as a whole unit, installation not required.
- Removable side doors
- **Colour:** Grey or black
- Ventilation fans
- Fixed shelf(s)
- Wheels
- Cables can exit from top or bottom of rack
- Include M6 screws
- Front and back door removable, switchable to open left or right
- Up to 850 kg loading

原個送到  
無需安裝

Color  
Grey | Black



Sizes from 9U to 47U



Front



Side

# CAMBRIDGE

Server | Comms | AV Rack

Web: [Cambridge-rack.com](http://Cambridge-rack.com)

Tel: 8103-0308

Email: [sales@81030308.com](mailto:sales@81030308.com)

## Standard features for racks of 800 width models



### 4pc of vertical cable trunks

- 2 x front
- 2 x back

### Perfect racking solution for:

- Telecommunication equipment

### 19" rackount angle

# CAMBRIDGE

Server | Comms | AV Rack

Web: [Cambridge-rack.com](http://Cambridge-rack.com)

Tel: 8103-0308

Email: [sales@81030308.com](mailto:sales@81030308.com)

## Floor Type Server Rack: 9U to 47U

Standard Features

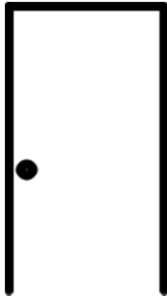

### Doors

- Glass door on front
- Metal door on back
- Removeable (both doors)
- Switchable to open from left or right (both doors)



19" rails on Front and Rear



**Delivered as 1 unit**

Installation not required

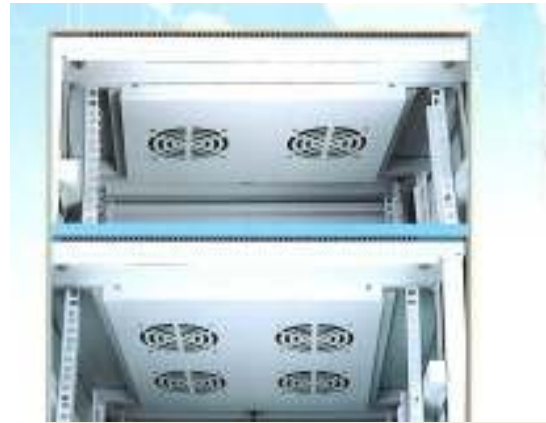

Box fans:

- 2 for 600 depth
- 4 for 800+ depth



Removable tempered glass door



Quick release side doors

Round Key Lock on  
Front and Back



# CAMBRIDGE

Server | Comms | AV Rack

Web: [Cambridge-rack.com](http://Cambridge-rack.com)

Tel: 8103-0308

Email: [sales@81030308.com](mailto:sales@81030308.com)

## Wall Mount server rack: 6U to 22U

### Standard Features



- Mounts to wall or place on floor
- High quality cold roll steel
- Front tempered glass door (with lock)
- Delivery as a whole unit, installation not required.
- Air ventilation thru holes on top / bottom frame
- Color: Grey or Black



Cable access channel on top

Quick Release Side Doors

M6 screws and nuts included

 **20**

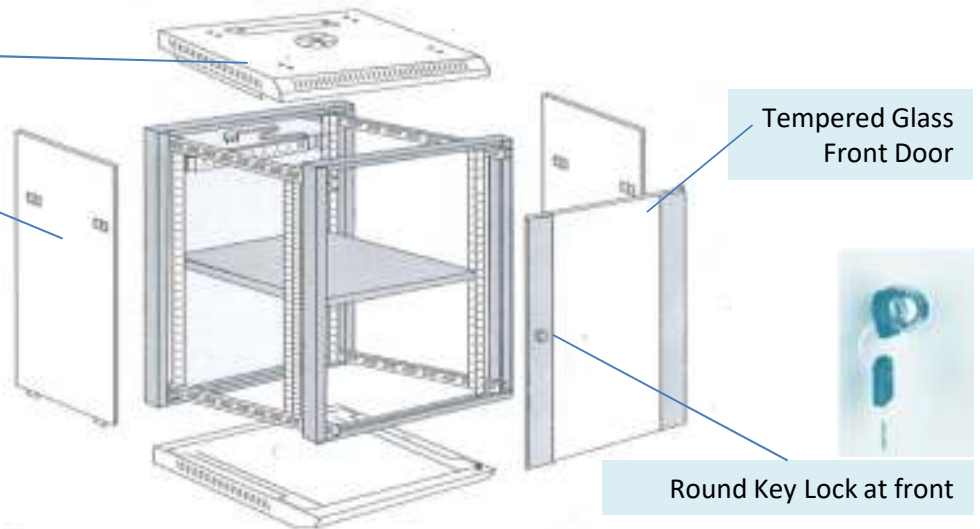

Tempered Glass Front Door

Round Key Lock at front

U	Available Width (mm)	Available Depth (mm)	Height (mm)	Fixed shelves	FAN
6	600	450 / 580	380	Purchase Separately	Purchase Separately
9	600	450 / 580	510		
12	600	450 / 580	640		
15	600	450 / 580	780		
18	600	450 / 580	910		
22	600	450 / 580	1100		

# CAMBRIDGE

Server | Comms | AV Rack

Web: [Cambridge-rack.com](http://Cambridge-rack.com)

Tel: 8103-0308

Email: [sales@81030308.com](mailto:sales@81030308.com)

## Open Rack

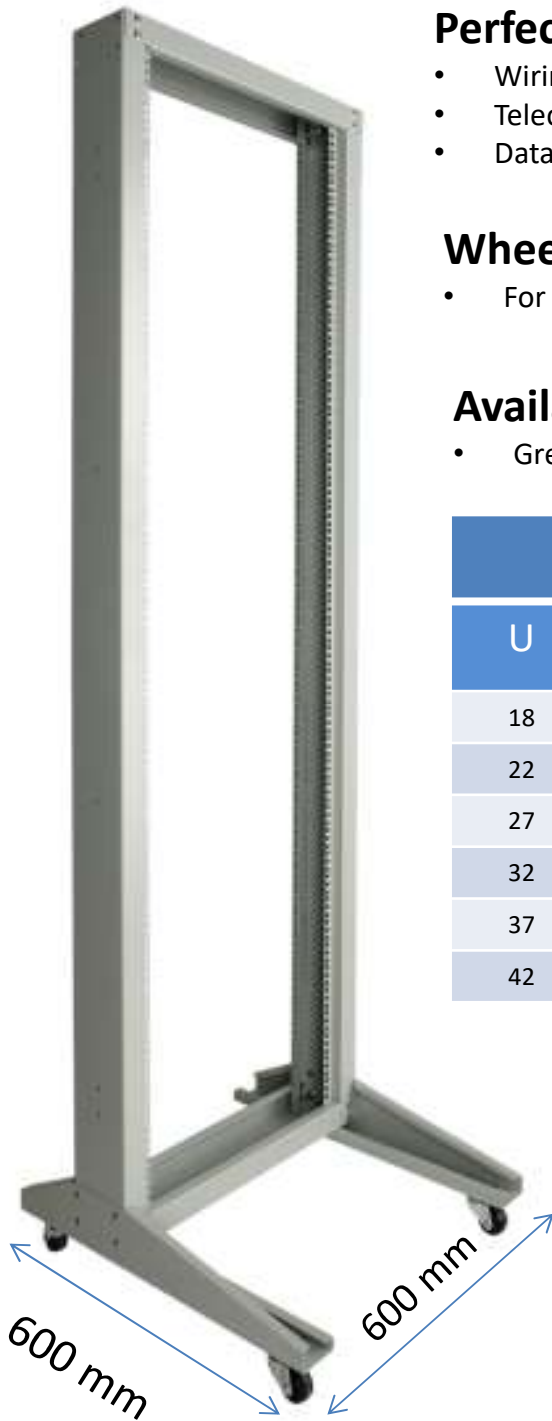

### Perfect racking solution for:

- Wiring closets
- Telecom rooms
- Data centers.

### Wheels included

- For easy moving

### Available colors

- Grey / Black

Sizes	
U	Height with wheels(mm)
18	990
22	1170
27	1400
32	1610
37	1840
42	2050



### \* Optional Fixed shelf for Open Rack

Available sizes:

- 280mm depth
- 430mm depth

Color: Grey / Black



# CAMBRIDGE

Server | Comms | AV Rack

Web: [Cambridge-rack.com](http://Cambridge-rack.com)

Tel: 8103-0308

Email: [sales@81030308.com](mailto:sales@81030308.com)

## Optional Accessories

### Vented Doors 網孔門



*Improves air flow*

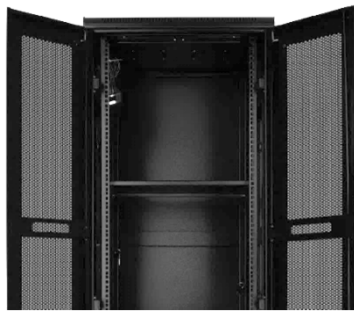

Double opening  
vented doors  
雙開網孔門

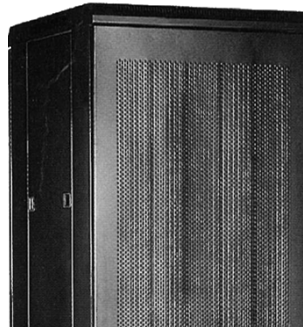

Single opening  
vented door  
單開網孔門



Single Opening Glass door  
with vented panel  
玻璃門配網孔框

### Fixed shelves

- Color (Grey / Black)



### 7 WAY PDU

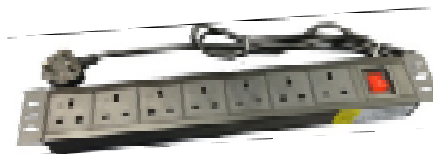

### Sliding Shelf (Color: Grey / Black)



Drawer with lock (2U/3U)  
Color: Black



Handle Lock  
手把鎖 (月光鎖)



U mark printing



Blank panel cover  
1U to 4 U  
Grey or black

L guide rail  
L 導軌

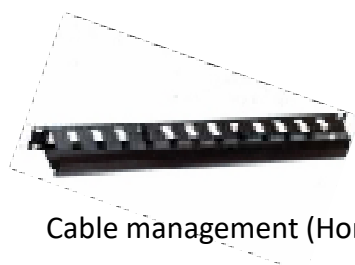

Cable management (Horizontal)



Fan



Wheel with Lock



Lock on side doors